

J.O.E.® Onboarding

Check smartphone and J.O.E.® app version:

- Is the latest app version installed?
- Android version 8.0 (or higher)
- iOS version 16.0 (or higher)

Check permissions:

- Are Location Services for the J.O.E.® app turned ON?
- Have all permissions been given to J.O.E.®?
- Is the WLAN allowing everything?
- Is your Bluetooth ON?

Check WLAN settings:

- Router frequency set to 2.4 GHz (not 5 GHz)
- Channels 1 to 11 (not higher)
- Disable 20/40 MHz coexistence
- The Wi-Fi password must be known

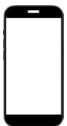

- ▶ Connect your smartphone to the WLAN and switch on Bluetooth.
- ▶ Open the location settings.
- ▶ Always allow location access for the J.O.E.® app.

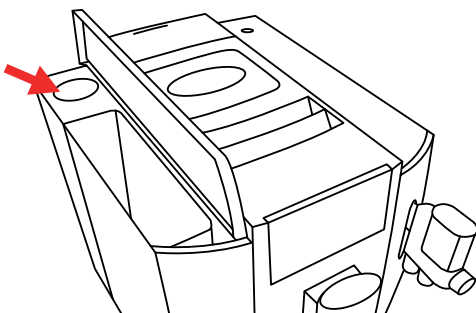

- ▶ Open the water tank cover.
- ▶ Plug the Wi-Fi Connect into the coffee machine's service socket.
(Some models already have it plugged in.)
- ▶ Switch on the coffee machine.

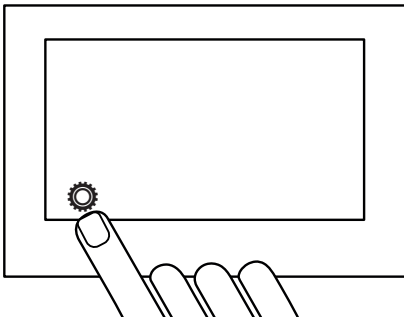

▶ Touch the 'Machine settings'  symbol.

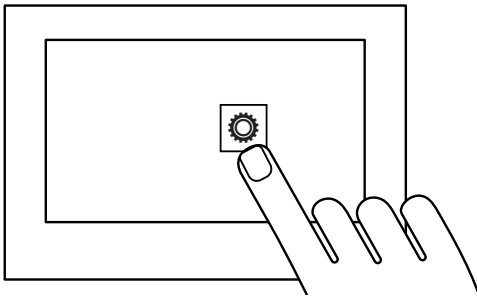

▶ Touch the 'Machine settings'  symbol.

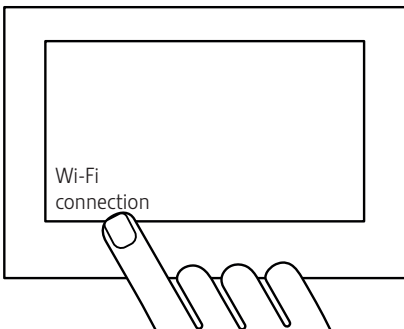

▶ Touch 'Wi-Fi connection'.

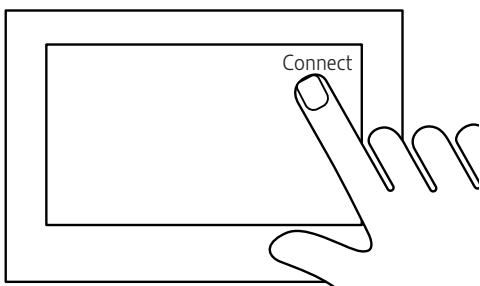

▶ Touch 'Connect'.

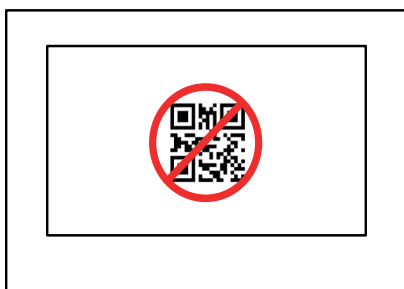

▶ Do not use the displayed QR code.
▶ Continue with the next step of these instructions.

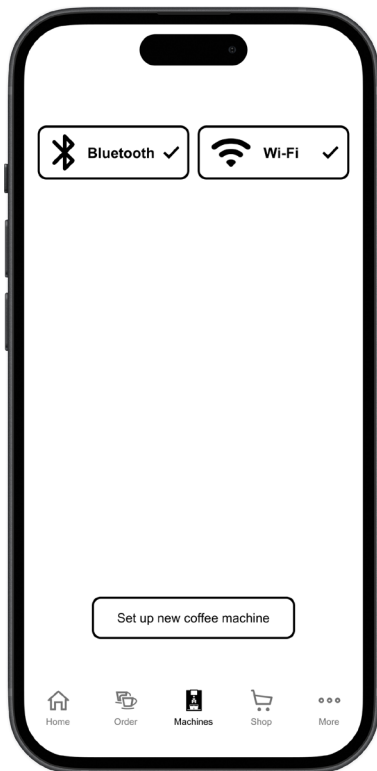

- ▶ Open the J.O.E.® app on your device.
- ▶ Touch 'Machines'.
- ▶ Touch 'Set up new coffee machine'.

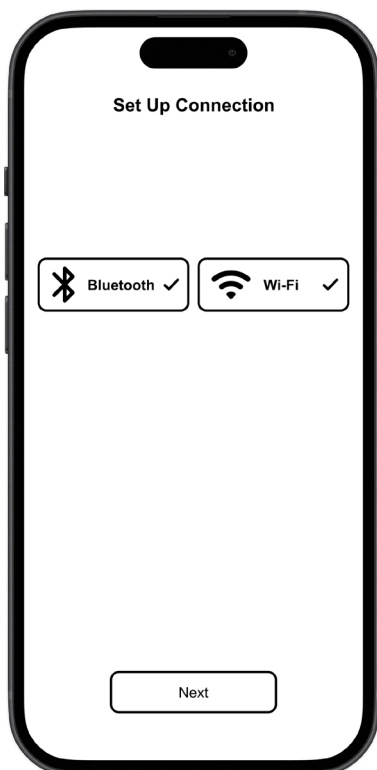

- ▶ Check whether Bluetooth and Wi-Fi are active (outlined green).
- ▶ If not, connect your device to your WLAN and switch on Bluetooth.
- ▶ Touch 'Next'.

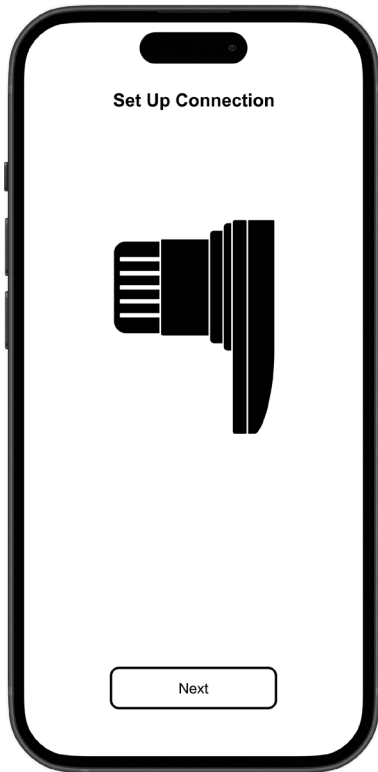

- ▶ If you have already plugged in the Wi-Fi Connect, you can touch 'Next'. Otherwise, first plug in the Wi-Fi Connect as described on page 1.

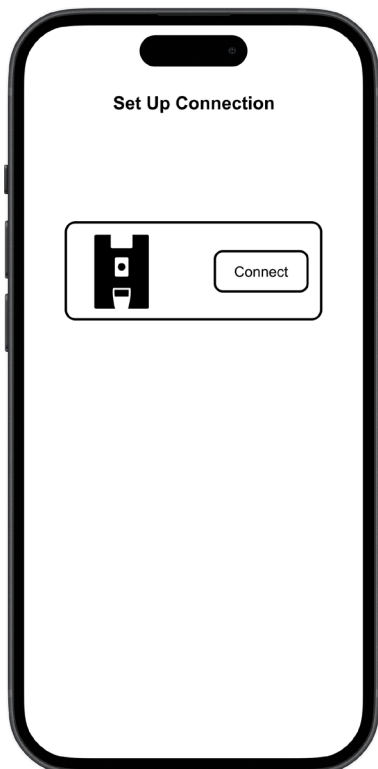

- Your coffee machine should now be displayed.
- ▶ Touch 'Connect'.

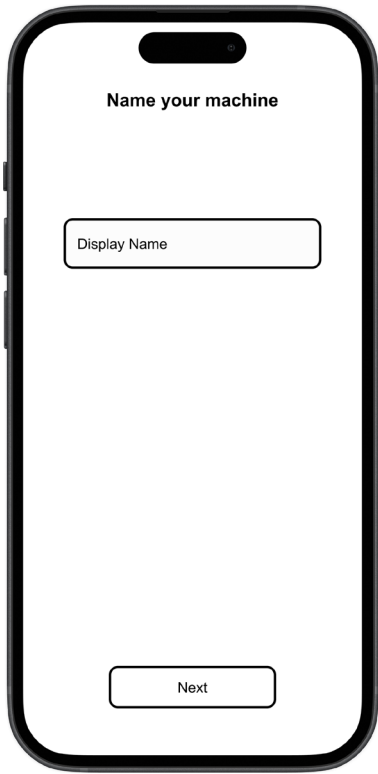

► Give your coffee machine a name and touch 'Next'.



► Enter the desired PIN or skip this step.



- ▶ Enter Wi-Fi password. It must be the same as the one you used to connect your smartphone.
- ▶ Touch 'Next'.

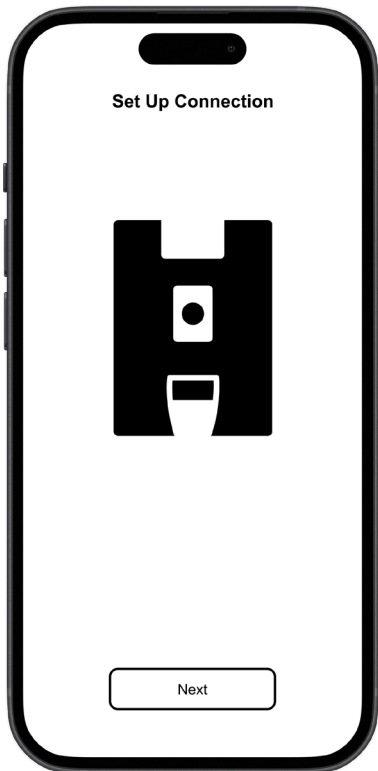

- ▶ Touch 'Next'.

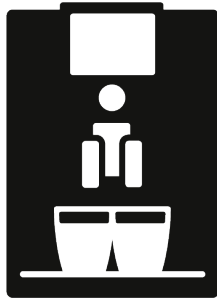

- ▶ Go back to the start screen.
(Some machines do this automatically.)

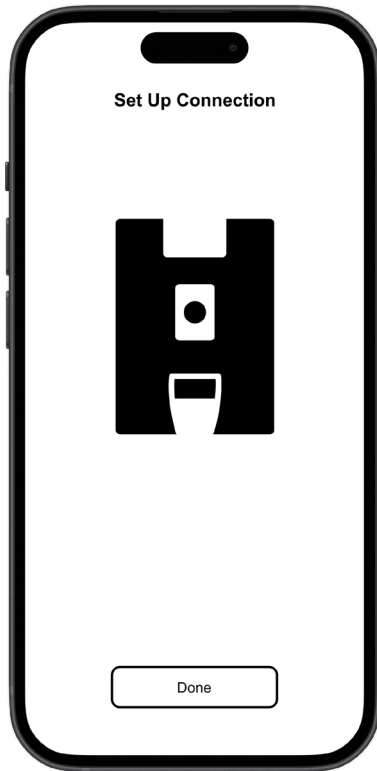

- ▶ Touch 'Done'.

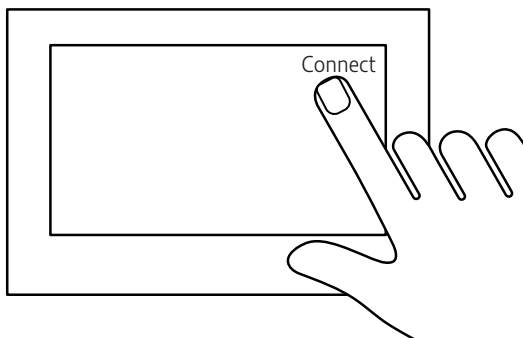

- ▶ Touch 'Connect' to confirm the connection with J.O.E.®. You need to do this within 30 seconds.



If you are unable to connect, check all the settings specified in the requirements and try again. If you are still experiencing problems with onboarding, in the J.O.E.® app go to 'More' (bottom right) and call our Digital Customer Support.